

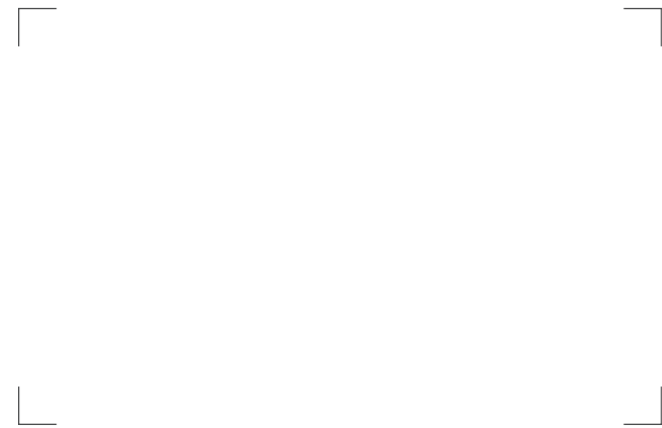

03 2021 BMW India Pvt. Ltd. Printed in India 2021.



THE



**For more information, call 1800 102 2269.**

The models, equipment and possible vehicle configurations illustrated in this brochure may differ from vehicles supplied in the Indian market. For precise information, please contact your local Authorised BMW Dealer. Subject to change in design and equipment. © BMW India Pvt. Ltd., Gurgaon, India. Not to be reproduced wholly or in part without written permission of BMW India Pvt. Ltd., Gurgaon, India.

[/bmwindia](#) [YouTube /bmwindia](#) [/bmwindia](#) [/bmwindia\\_official](#) [/bmwindia](#)



# THE NEW BMW 2 SERIES GRAN COUPÉ.



**17** Highlights



**22** Original BMW Accessories

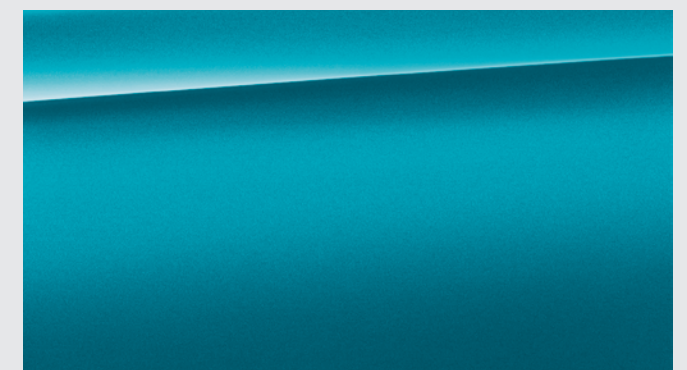

**23** Worlds of colour

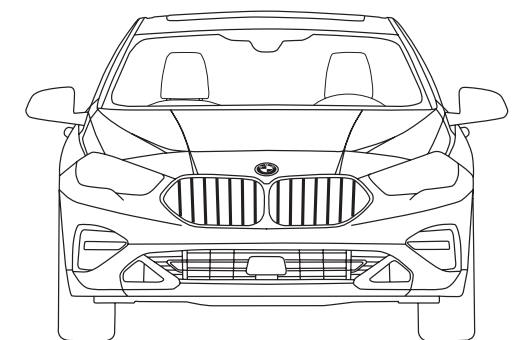

**24** Technical data

WICKED



WILD



F A B U L O U S



F U R I O U S

# ENGINE.

**BMW EFFICIENTDYNAMICS.**  
LESS EMISSIONS. MORE DRIVING PLEASURE.

## BMW 220d

BMW TwinPower Turbo 4-Cylinder diesel engine with 140 kW (190 hp) and 400 Nm torque  
Acceleration 0–100 km/h: 7.5 seconds  
Top speed: 233 km/h  
Combined fuel consumption: 18.64 km/l<sup>1</sup>  
Combined CO2 emissions: 142 g/km<sup>1</sup>

## BMW 220i

BMW TwinPower Turbo 4-Cylinder petrol engine with 141 kW (190 hp) and 280 Nm torque  
Acceleration 0–100 km/h: 7.1 seconds  
Top speed: 240 km/h  
Combined fuel consumption: 14.82 km/l<sup>1</sup>  
Combined CO2 emissions: 160 g/km<sup>1</sup>



# DYNAMICS AND EFFICIENCY

## AERODYNAMICS.

Targeted Aerodynamic changes to the vehicle body such as, Air Curtain and Air Blades improve its air resistance. The airflow-optimised components contribute not only to reduced fuel consumption, but also reduces the level of noise in the interior.

## DRIVING EXPERIENCE CONTROL INCL. ECO PRO.

The Driving Experience Control lets the driver choose between the standard COMFORT mode, ECO PRO mode which is geared towards efficiency, and SPORT mode which enables even more dynamic driving. ECO PRO mode adjusts the characteristics of the accelerator, steptronic transmission and the heating/air conditioning settings to make the drive as fuel-efficient as possible.

## LAUNCH CONTROL.

With the Launch Control function, drivers benefit from the best possible acceleration with optimized traction and maximum dynamics from a standstill.

## BMW EFFICIENT DYNAMICS.

Get more out of every litre of fuel with BMW Efficient Dynamics: better performance, greater efficiency and a heightened driving pleasure. Technical innovations that lower fuel consumption while simultaneously increasing driving pleasure mean that pure dynamics come standard in every BMW.

## BRAKE ENERGY REGENERATION.

With Brake Energy Regeneration, the alternator generates electricity primarily when you brake or take your foot off the accelerator. Previously unused kinetic energy is thereby transformed into electrical energy and fed into the battery.

## INTELLIGENT START/STOP FUNCTION.

The Intelligent Auto Start/Stop Function uses data from the navigation system, camera and if it is detected that further travel is imminent (e.g. during a turning manoeuvre), the engine is not automatically switched off when the vehicle stops.

# SAFETY.

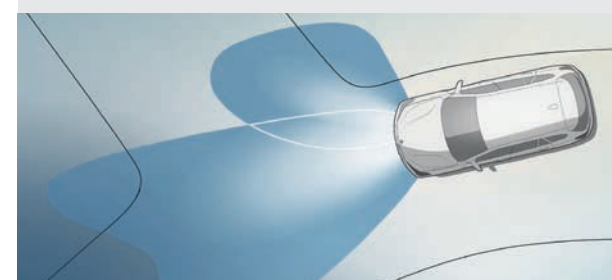
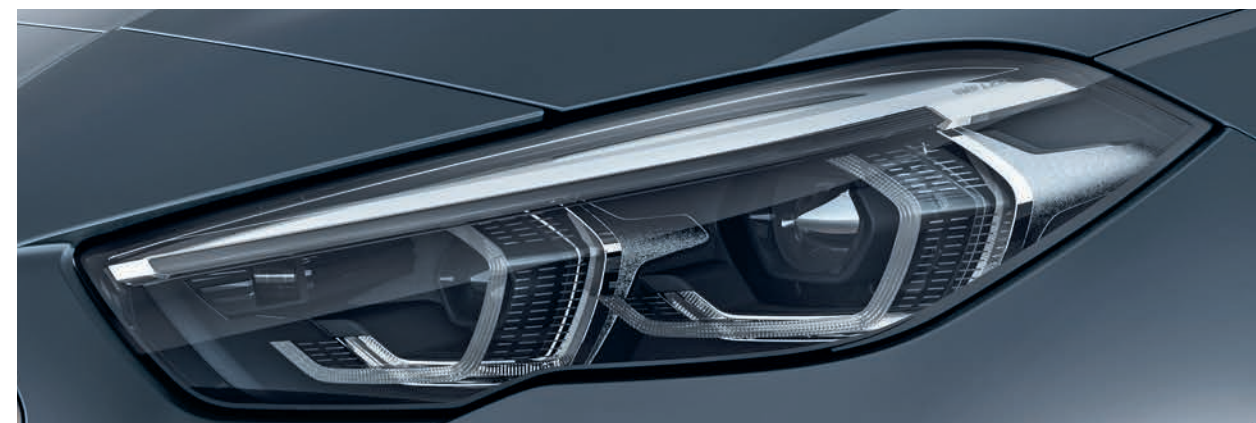

**LED Headlights** with low-beam and high-beam using BI-LED technology as well as direction indicators in full LED technology. The equipment also features cornering lights and daytime running lights that help improve driving safety by optimally illuminating the road ahead.

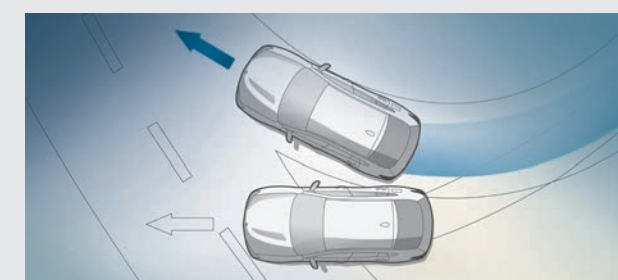

**Dynamic Stability Control (DSC)** constantly assesses the vehicle's movements and ensures directional stability and traction.

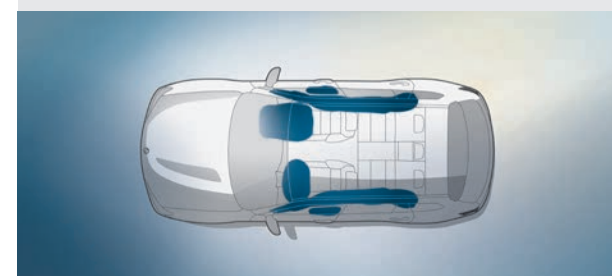

**Airbags for driver and front passenger** are an integral part of the optimally coordinated safety components in a BMW. A total of six airbags offer targeted protection: driver and front passenger airbags, head airbags for the whole side window area, and side airbags in the front seat backrests.

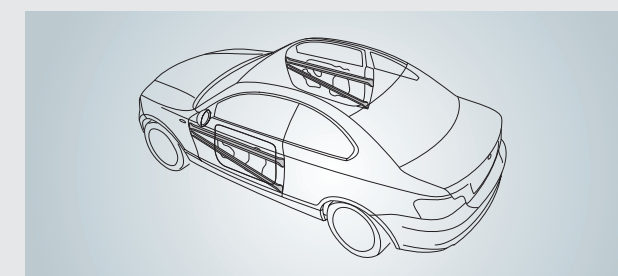

**Side-Impact Protection** ensures greater safety. Thanks to the directions of the beams and node joints and selective use of high-strength materials, the functionally designed passenger cell structure provides maximum passive safety in the event of a front, side or rear impact.

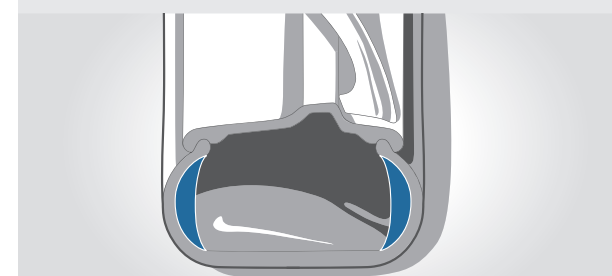

**The Runflat Indicator (TDI)** warns the driver with a light in the Control Display when there is a slight drop in tyre pressure. When there is a large pressure drop, there is an additional acoustic warning.

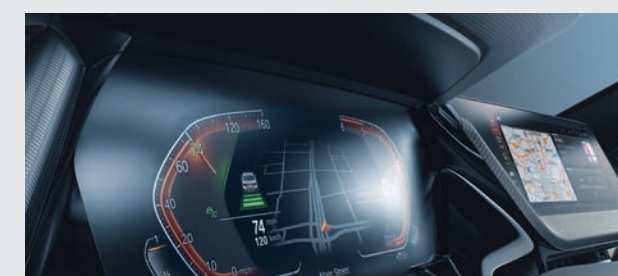

**Attentiveness Assistant** analyses the driving behaviour of the driver and suggests when to take a break in the control display. Functions from 70 km/h and higher.

<sup>1</sup> Performance data as measured in the emission test done under controlled conditions of environment, driving cycle, fuel, etc. as specified in Rule 115 of Central Motor Vehicle Rules, 1989.

## DRIVER ASSISTANCE AND CONNECTIVITY.

**BMW ConnectedDrive**  
So connected, you're free.



### BMW VIRTUAL ASSISTANT

'Hello, BMW. Who are you?' Wouldn't it be incredible if your BMW acted like your personal assistant? Communicate in a new and easy way with your vehicle using the BMW Virtual Assistant. It knows you, and helps out whatever the situation. It can explain everything about your vehicle and helps you get better acquainted with your BMW. You can even assign your own personal activation word.

### BMW GESTURE CONTROL

With BMW Gesture Control, certain functions can be operated by means of defined hand movements. For certain operations the system will, for example, recognise gestures such as 'swiping' or 'pointing' for accepting or rejecting an incoming call, or circular motions of the index finger to adjust volume.

### BMW LIVE COCKPIT PROFESSIONAL

The BMW Live Cockpit Professional with navigation function includes a high-quality display network consisting of a high-resolution 10.25" (26 cm) Control Display that can be operated by touch and a fully digital 10.25" (26 cm) Instrument Display. The BMW Operating System 7.0 can also be operated via the iDrive Touch Controller.

### SMARTPHONE INTEGRATION

Enables wireless and comfortable usage of your phone in your vehicle via Apple CarPlay®.

### BMW OPERATING SYSTEM 7

The innovative operating concept of the BMW Operating System 7 enables even easier operation of vehicle functions via speech, touch screen and iDrive control - very intuitively. For this purpose, the functionality of the controller has been upgraded. So now the apps menu can be selected directly.

## COMFORT AND FUNCTIONALITY.

Equipment 09 | 10



### PANAROMA GLASS ROOF

When open, the Panorama Glass Roof provides a great deal of fresh air. Closed, it creates a bright, light-flooded atmosphere in the interior. It opens and closes completely automatically at the push of a button, or remotely, and is equipped with slide and lift functions, roller sunblind and wind deflector.

### THROUGH-LOADING SYSTEM

The Through-loading System includes rear seat backrests that can be divided in a 40:20:40 ratio for the greatest possible flexibility.

### AUTOMATIC AIR CONDITIONING

The Automatic Air Conditioning with 2-Zone Control and automatic target temperature control features separate controls for you and your front passenger. It also includes Automatic Air Recirculation (AAR), a micro-activated carbon particulate filter, a fogging and solar sensor, as well as rear air vents.

### ATMOSPHERIC LIGHTS PACKAGE

The atmospheric Lights Package contains various LED lights and yields an ambience of pure quality in the interior. The six selectable light designs light up the interior with a stylish combination of

direct and indirect lights. Additionally, you are greeted with an impressive welcome display of the exterior LEDs.

### SPORT SEATS

The Sport Seats for driver and front passenger are characterised by seat and backrest bolsters that are larger than those on the standard seats and, together with adjustable thigh support, for excellent ergonomics and better lateral support during fast cornering. In addition to the seat depth (mechanical), the backrest width (electric) can also be adjusted on the driver's seat.

**Standard Model Equipment:**

- Full LED Headlamps with hexagon icon design
- Full LED Tail Lights with L-shaped design, dark version with dynamic brake light
- Panoramic Glass Roof
- Rain Sensor and Automatic Driving Lights
- Exterior mirror electric folding
- Interior rear-view mirror with automatic anti-dazzle function
- Standard Seats
- Electrical Seat Adjustment for driver and passenger with memory function for driver
- Front armrest, sliding with storage compartment
- Centre armrest in the rear with 2 cup holders
- Floor Mats in velour
- Rear seat 40:20:40 split
- Parking assistant
- Tyre pressure indicator
- Driving Experience Control incl. ECO PRO
- Performance Control
- Cruise Control with Braking Function
- Automatic Air Conditioning with 2-Zone Control
- Storage Compartment Package
- Ambient Light package
- BMW Live Cockpit Plus

**Interior Design:**

- Anthracite floor mats
- Illuminated Trim

**Exterior Design:**

- BMW Kidney Grille frame in High-Gloss Chrome with grille struts in High-Gloss Black
- Window exterior frame in Black High Gloss
- Mirror Cap painted in body colour
- Twin exhaust tail-pipe in Chrome High-Gloss finish



**Standard Model Equipment:**

- Full LED Headlamps with hexagon icon design
- Full LED Tail Lights with L-shaped design, dark version with dynamic brake light
- Panoramic Glass Roof
- Rain Sensor and Automatic Driving Lights
- Exterior mirror electric folding
- Interior rear-view mirror with automatic anti-dazzle function
- Sport Seats for driver and front passenger
- Electrical Seat Adjustment for driver and passenger with memory function for driver
- Front armrest, sliding with storage compartment
- Centre armrest in the rear with 2 cup holders
- Floor Mats in velour
- Rear seat 40:20:40 split
- Parking assistant
- Tyre pressure indicator
- Driving Experience Control incl. ECO PRO
- Performance Control
- Cruise Control with Braking Function
- Automatic Air Conditioning with 2-Zone Control
- Storage Compartment Package
- Ambient Light package
- BMW Live Cockpit Professional
- Smartphone Integration

**Interior Design:**

- Dashboard with contrasting seams
- Door Sill Finishers: aluminium inserts with "BMW" designation
- Anthracite Floor Mats with surround in contrasting colour (according to the contrasting seam in the instrument panel and centre console)
- Illuminated Trim

**Exterior Design:**

- BMW Kidney Grille frame in High-Gloss Chrome with grille struts in High-Gloss Black
- Air Inlet cover panels (left/right of front grille, bottom centre) in body colour
- Roof mouldings in body colour
- Window exterior frame in Satinized Aluminium
- Mirror Cap painted in body colour
- Twin exhaust tail-pipe in Chrome High-Gloss finish
- Bumper trim in Black High-Gloss







**Interior Design:**

- Door Sill Finishers: Aluminium inserts with "M" designation
- M-specific Floor Mats with M lettering
- Dashboard with contrasting seams
- M leather Steering Wheel
- Vehicle Key with exclusive M designation
- BMW Individual Headliner Anthracite
- Illuminated Trim

**Exterior Design:**

- M Aerodynamics Package with front apron, side skirts, wheel arch trim and cladding in body colour, rear apron with diffuser insert in Dark Grey
- BMW Kidney Grille with exclusively designed vertical slats with front sides in Aluminium Matt, grille frame in Chrome High-Gloss
- LED Fog Lights integrated into the bumper system, each with 3 LEDs in horizontal arrangement
- Air Inlet cover panels in Black High-Gloss
- M designation on the sides
- Side Sill Inlays in Dark Grey
- Roof mouldings in body colour
- Window exterior frame in Satinized Aluminium
- Twin exhaust tail-pipe in Chrome High-Gloss finish
- Bumper trim in Black High-Gloss



# EQUIPMENT HIGHLIGHTS.



When open, the **Panorama Glass Roof** provides a great deal of fresh air. Closed, it creates a bright, light-flooded atmosphere in the interior. It opens and closes completely automatically at the push of a button or with the vehicle key and is equipped with slide and lift functions, a roller sunblind and wind deflector.



The **BMW Live Cockpit Professional** with navigation function includes two high-quality displays consisting of a high-resolution 10.25" Control Display that can be operated by touch and a fully digital 10.25" instrument display. The BMW Operating System 7.0 can also be operated via the iDrive Touch Controller.



The **Atmospheric Lights Package** contains various LED lights and yields an ambience of pure quality in the interior. The six selectable light designs light up the interior with a style.



The **Automatic Air Conditioning with 2-Zone Control** and automatic target temperature control features separate controls for you and your front passenger. It also includes Automatic Air Recirculation (AAR), a micro-activated carbon particulate filter, a fogging and solar sensor, as well as rear air vents.

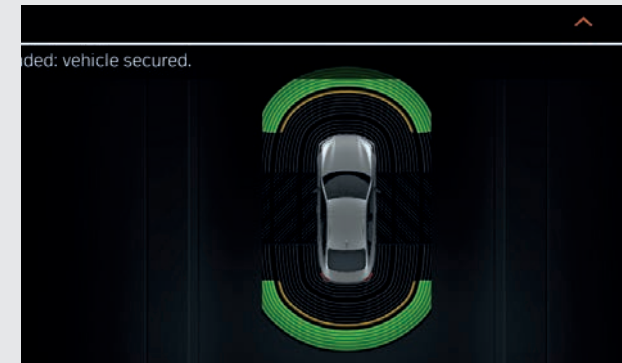

**Parking Assistant** makes parking the vehicle easier. The Rear-View camera provides a clearer view behind the vehicle. Active Park Distance Control offers increased protection against damage caused by parking. Parking Assistant parks the vehicle automatically, parallel or perpendicular to the street, and leaves parallel parking spaces. The Reversing Assistant supports you when reversing, e.g. in narrow lanes.



With the **Smartphone Integration Package**, you can connect your phone through a Wireless connection and use the control display while driving to access numerous features of your smartphone like Messaging, Maps, Music etc.



**Micro-activated Carbon Particulate Filter** for fresh and recirculated air.



The **Sport Seats** for driver and front passenger are characterised by seat and backrest bolsters that are larger than those on the standard seats and, together with adjustable thigh support, for excellent ergonomics and better lateral support during fast cornering. In addition to the seat depth (mechanical), the backrest width (electric) can also be adjusted on the driver's seat.



The **Multifunctional Steering Wheel with Paddle shifters** can be used to operate the telephone, voice control and audio functions via the buttons on the steering wheel. The Cruise Control with braking function can be operated via the steering wheel for comfortable cruising.



The **8-Speed Steptronic Transmission and 7-Speed Steptronic Transmission** with double clutch technology combines efficiency with smooth gearshifts and outstanding driving comfort, thanks to tightly spaced gear ratios and fast engine speed transitions. It therefore unites superb comfort with impressive dynamics and increased fuel efficiency.

# EQUIPMENT HIGHLIGHTS.



**LED Headlights** with low beam and high-beam using BI-LED technology as well as direction indicators in full LED technology. The equipment also features cornering lights and daytime running lights that help improve driving safety by optimally illuminating the road ahead.



**LED Fog Lights** increase short-range visibility in fog or precipitation, improving night-time driving safety.



The **Lights Package** also includes a welcome greeting. When the vehicle is unlocked, an LED light source in the driver's-side exterior mirror projects onto the ground.



The **Frameless Interior Mirror**, with electromagnetic coating, consists of automatic anti-dazzle function via integrated sensors that measure light incident from behind and automatically dim the interior mirror if the measured light intensity is high enough to cause dazzling.



The window-frame surround in Aluminium satinized finish further accentuates the **Frameless Doors**.

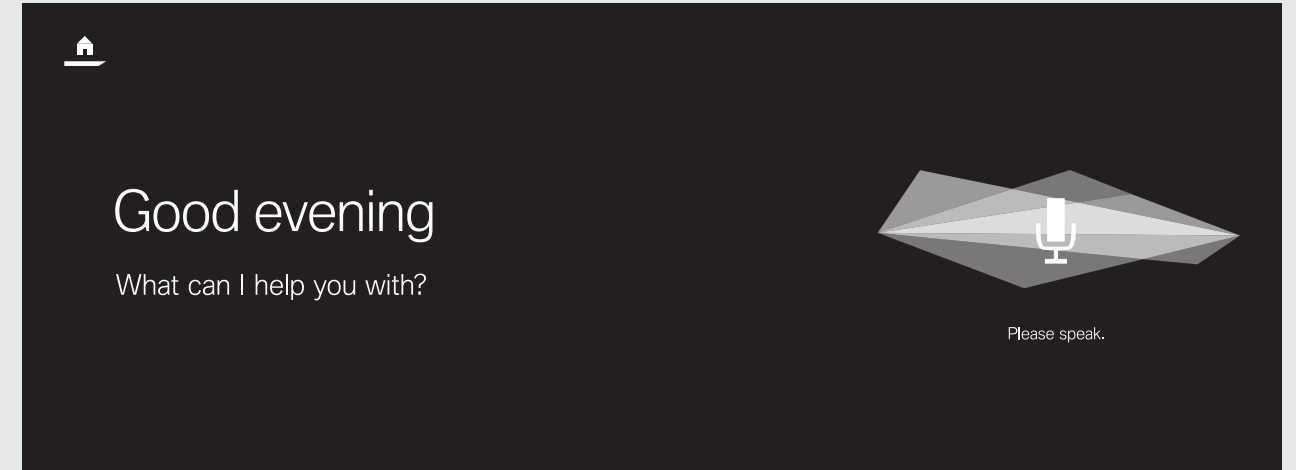

"Hey BMW. Who are you?" Wouldn't it be incredible if your BMW was also your personal assistant? Communicate with your vehicle using the **BMW Virtual Assistant**. It knows you, gets better every day and helps out whatever the situation. You can assign your own personal activation word. It can explain everything about your car and helps you to get to know your BMW even better.



The **Hi-Fi Loudspeaker System** lets you enjoy your favourite music in superb fidelity, thanks to the powerful amplifier, sophisticated equalizer and high-performance speakers.



With **BMW Gesture Control**, selected functions can be operated by means of defined hand movements. Simple gestures such as 'swiping' or 'pointing' are identified in the recognition area above the centre console and trigger functions such as accepting or rejecting an incoming telephone call, proceeding or cancelling navigation as well as starting and ending voice recordings.



Telephony with **Wireless Charging** offers a comprehensive telephony package with Bluetooth connectivity.



The **Reversing Assistant** records up to 50 m of the road you have driven forwards so that it can reverse the vehicle automatically in the same direction if you wish. The distance of the remaining route is shown in the image of the Rear View camera.

## M PERFORMANCE PARTS



**BMW M Performance Kidney Grille, Black.** The High-Gloss Black kidney grille gives the front of the car an even more dynamic and athletic look. The glossy Black surrounds make the air inlet appear more striking and bigger than ever.



**BMW M Performance Rear Spoiler, Black.** The BMW M Performance rear spoiler underscores the individual appearance of the vehicle and guarantees optimised aerodynamic values.



**BMW Exterior Mirror Caps, Carbon Fibre.** The striking Carbon Fibre exterior mirror caps underscore the vehicle's high-tech pedigree, adding an individual athletic touch.



**BMW M Performance Rear Bumper Trim in Carbon Fibre.** Accessory also available in Black Chrome.



**BMW M Performance Floor Mats, Front and Rear.** The M Performance floor mats perfectly round out the upscale, dynamic appearance of the car's interior.

## WHEELS AND TYRES.



**18" BMW Light Alloy Wheels Y-spoke 553 M, Orbit Grey**



**18" BMW Light Alloy Wheels Y-spoke 554 M, Matt Black**



**18" BMW M Light Alloy Wheels Double-spoke style 819 M Bicolour with runflat tyres**



**17" BMW Light Alloy Wheels Double-spoke style 549 with runflat tyres**



**BMW Floating Hub Cap**

Allloys shown in the brochure are subject to availability.

## TRAVEL AND COMFORT ACCESSORIES.

21 | 22



**BMW Baby Seat Group 0+ and BMW Junior Seat Group 1 & 2/3** can be adjusted as the child grows and offers maximum safety and comfort for children aged up to 12 years.



**BMW Travel & Comfort System - Clothes Hanger.<sup>1</sup>** The Travel & Comfort System clothes hanger in an attractive BMW design makes it possible to hang pieces of clothing on the rear side of the backrest.



**BMW Travel & Comfort System - Universal Cradle.<sup>1</sup>**



The **BMW Spectacle Case** with BMW designation keeps glasses stowed safely and easily within reach.



**BMW Travel & Comfort System - Folding Table.<sup>1</sup>**

## UNIVERSAL ACCESSORIES.



**BMW Fitted Luggage Compartment Mat.** The anti-slip, waterproof and durable mat with a border helps protect the luggage compartment.



**BMW All-Weather Floor Mats** protect against moisture and dirt in the front footwell. Featuring a Black design with a stainless steel inlay, they complement the interior.



**BMW Advanced Car Eye 2.0.** A highly sensitive full-HD camera that captures events in front and behind the car, even when it is parked.



**BMW Protective Mat Loading Sill** made of water-repellent material.



With the **BMW Wireless Charging Station Universal** smartphones can be charged without a cable, any time and anywhere.

<sup>1</sup> Only in conjunction with base carrier.

## EXTERIOR COLOURS.



Alpine White (Non-metallic)

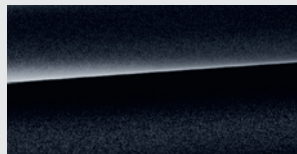

Black Sapphire (Metallic)



Melbourne Red (Metallic)

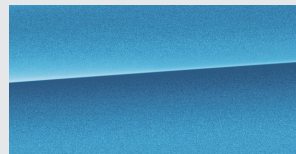

Seaside Blue (Metallic)

### M Sport



Misano Blue (Metallic)



Snapper Rocks Blue (Metallic)

### BMW INDIVIDUAL

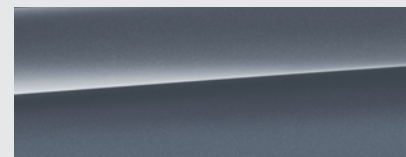

Storm Bay (Metallic)

## UPHOLSTERY

### SENSATEC

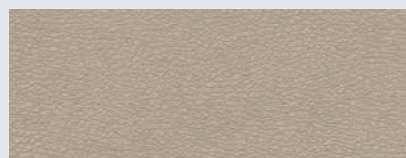

Sensatec Oyster

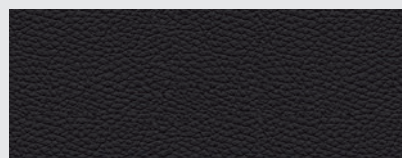

Sensatec Black

## INTERIOR TRIMS.

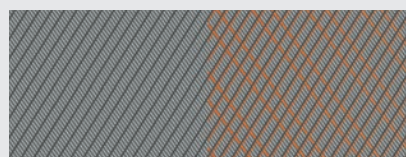

Interior trim finishers 'Illuminated Boston' with 'Mesh' accent on the instrument panel and door panel.

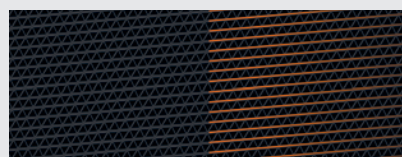

Interior trim finishers 'Illuminated Berlin' with 'High Matt' accent on the instrument panel and door panel.

## DIMENSIONS.

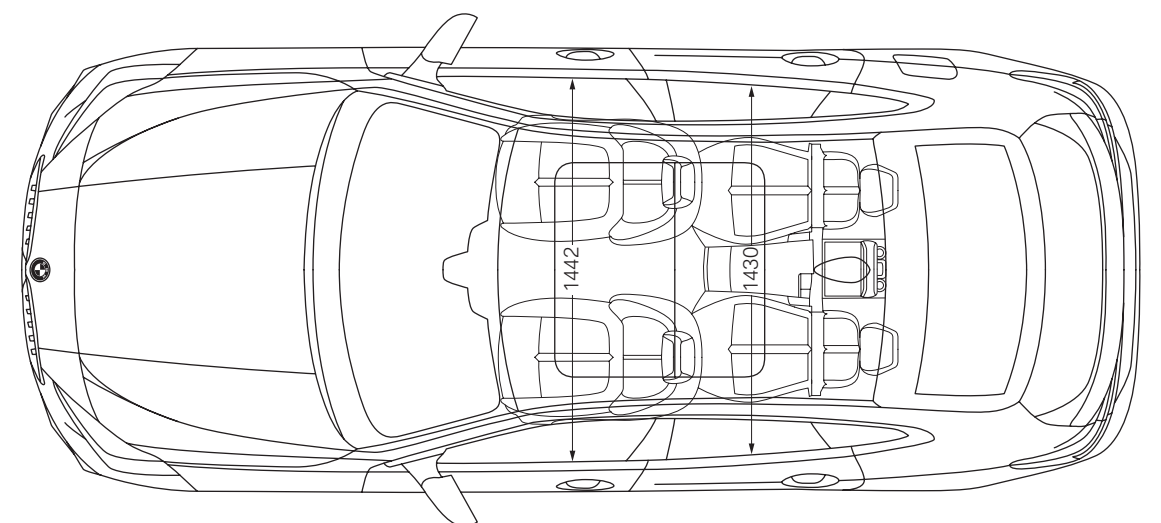
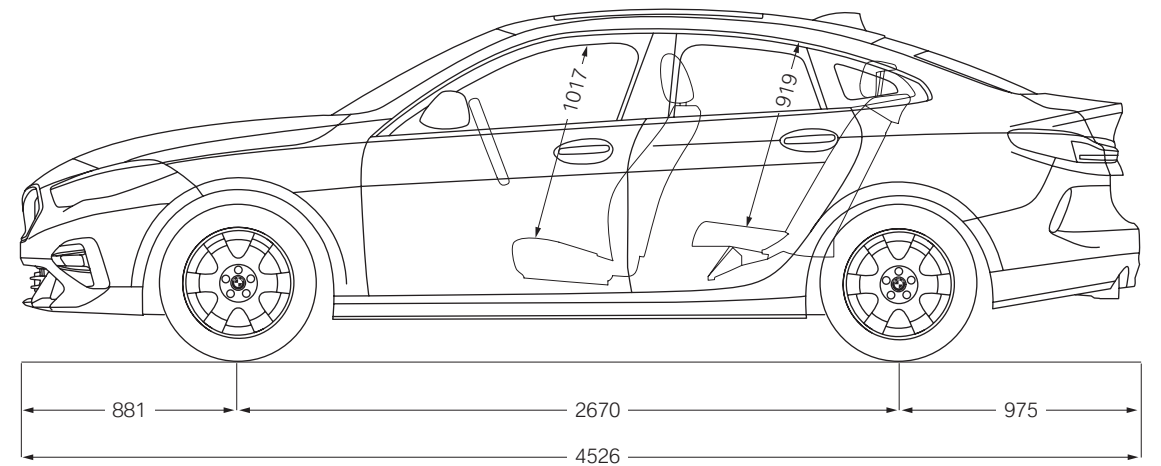
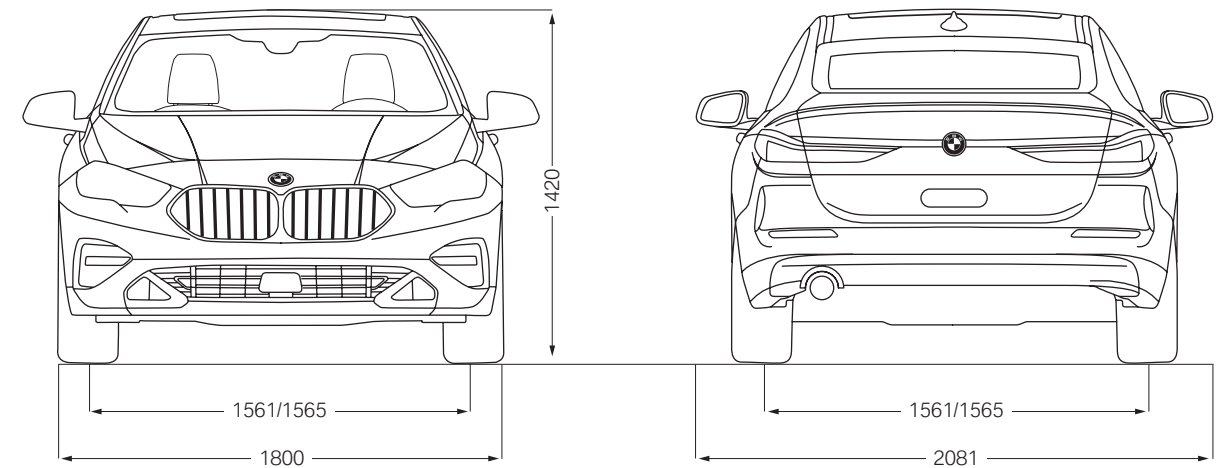

**[ Colours ]** The colours printed above are intended to provide you with a first impression of paints and materials available for your BMW. Experience has shown, however, that printed images of paint, upholstery and interior trim colours cannot faithfully reproduce the actual appearance of the originals. We recommend therefore that you consult your BMW partner who will be able to show you original samples and assist with special requests.

# BMW EXTENDED WARRANTY AND SERVICE PACKAGE.



A BMW 2 Series Gran Coupé will run well when it's kept well. And to make your journey one with complete peace of mind, we have packages under BMW Service and Repair Inclusive that take care of maintenance, inspection, wear and tear and warranty.

## BMW Service Inclusive (BSI)

A single up-front payment covers an extensive range of work on your BMW 2 Series Gran Coupé for a fixed period.

### Complete Cost Control.<sup>1</sup>

Integrate the cost of service work in your leasing and finance installments.

### Fully Flexible.

You have a choice of various packages with different durations and mileage. You can choose from 3 years with 40,000 km to 10 years with 2,00,000 km.

### Easily Transferable.

Consistent maintenance by trained BMW Certified Technicians and the use of Original BMW Parts secure the value of your car in the long term. In case you sell your car, BMW Service Inclusive is automatically transferred to the next owner – an additional selling point.

## BMW Repair Inclusive (BRI)

BRI offers the ease of extending the warranty of your car with unlimited mileage up to 6 years.

BRI too is automatically transferred to the next owner in the event of selling your car.

	Service Inclusive Packages »	Service Inclusive Basic	Service Inclusive Plus	Repair Inclusive
Scope of Services		Maintenance All maintenance work, including any BMW Original Parts and oil required.	Wear and Tear Additional wear and tear repairs including any Original BMW Parts required.	Repair Extension of your statutory right to claim for vehicle defects (warranty).
Maintenance	Engine oil service	✓	✓	
	Engine oil top ups	✓	✓	
	Vehicle check and standard scopes	✓	✓	
	Service/replace air filter	✓	✓	
	Service/replace fuel filter	✓	✓	
	Service/replace micro filter	✓	✓	
	Service/replace spark plugs	✓	✓	
	Service/replace brake fluid	✓	✓	
Wear & Tear	Replacement of front/rear brake pads		✓	
	Replacement of front/rear brake discs		✓	
	Replacement of clutch (if necessary)		✓	
	Replacement of wiper blades (once in a year)		✓	
	Extension of your statutory right to claim for vehicle defects (warranty)			✓

# BMW FINANCIAL SERVICES.

BMW Financial Services



In the world of BMW, world-class isn't limited to the vehicles we engineer. It also finds its way into the services we offer. BMW Financial Services is the most flexible and efficient way to realise your dream of owning a BMW. Our goal is to make your financing experience seamless at every step of your purchase so that nothing comes between you and the joy of driving your BMW.

At BMW Financial Services, you are assured of:

- Tailor-made finance options, as per your specific needs
- Quick approvals with fast turnaround time
- Special loyalty benefits
- Part payment facility
- In-house call centre that provides the best-in-class customer interaction

The BMW 2 Series Gran Coupé comes with an exclusive BMW 360° Plan. It has benefits at every step of the way, all to ensure Sheer Driving Pleasure.

### Easy to Buy.

The BMW 360° Plan allows you to pay low monthly installments as you only pay for what you use.

### Easy to Own.

BMW offers various options under Service and Maintenance Packages which further reduce your cost of ownership.

### Future Proof.

The BMW 360° Plan provides Assured Buyback value at the end of your finance contract.

For more information, contact the Finance and Insurance Manager at the nearest BMW Authorised Dealership.

<sup>1</sup> Applicable only with BMW India Financial Services Private Limited during the initial purchase of the vehicle (not on other finance or during upgrades).

# BMW INDIA NETWORK.

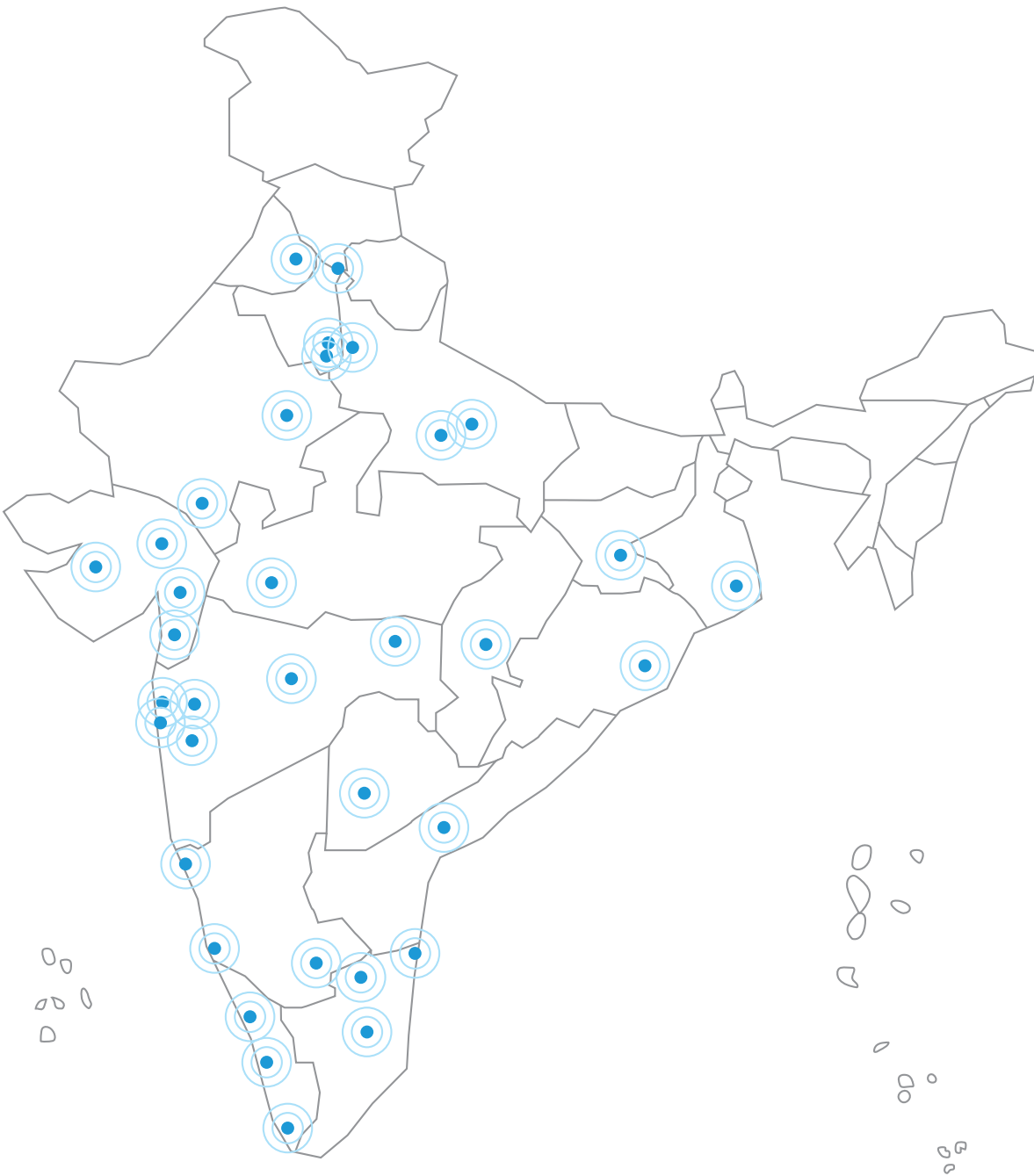

The pictorial representation does not purport to be the political map of India.

# DEALERSHIPS.

## NORTH

### BMW Bird Automotive

- SW 4IDC, MG Road, Gurugram
- S Golf Course Road, Sector 56 Gurugram

### BMW Deutsche Motoren

- S Mohan Cooperative, Mathura Road New Delhi
- W Shivaji Marg, Moti Nagar, New Delhi
- SW Sector 27B, Mathura Road, Faridabad
- SW Sector 63, Noida

### BMW Infinity Cars

- S Rajouri Garden, New Delhi
- W Mayapuri, New Delhi

### BMW Krishna Automobiles

- SW Industrial Phase 1, Chandigarh
- SW GT Road, Ludhiana

### BMW Sanghi Classic

- SW Tonk Road, Jaipur
- S Madri Industrial Area, Udaipur

### BMW Speed Motorwagen

- SW Chinhat, Lucknow
- SW Kalpi Road, Kanpur

## EAST

### BMW OSL Prestige

- S Silver Arcade, Kolkata
- W East Topsia Road, Kolkata
- SW Bhanpur, Cuttack

### BMW Titanium Autos

- SW Ormanjhi, Ranchi

## WEST

### BMW Bavaria Motors

- S Wellesley Road, Pune
- W Hadapsar, Pune
- SW Verna, Goa
- SW Chikalthana, Aurangabad

### BMW Eminent Cars

- SW Surat-Dumas Road, Piplod, Surat
- SW Sunpharma Road, Vadodara

### BMW Gallops Autohaus

- SW S G Highway, Sarkhej, Ahmedabad
- S Gondal Road, Rajkot
- W AJI GIDC, AJI Crossroads, Rajkot

### BMW Infinity Cars

- S Worli, Mumbai
- S Nariman Point, Mumbai
- S Vashi, Navi Mumbai
- W Lalbaug, Mumbai
- W Worli, Mumbai
- W Turbhe, Navi Mumbai
- SW Dewas Naka, Indore

### BMW Munich Motors

- SW Sarona, Raipur
- SW Hingna MIDC, Nagpur

### BMW Navnit Motors

- S Juhu, Mumbai
- S Malad, Mumbai
- W Andheri, Mumbai
- W Gokul Nagar, Thane

## SOUTH

### BMW Deutsche Motoren

- S Whitefield, Bengaluru
- W Whitefield, Bengaluru

### BMW EVM Autokraft

- SW Kalamassery, Kochi
- W Puthiyangadi, Calicut
- W Kochuveli, Trivandrum

### BMW KUN Exclusive

- S Khairtabad, Hyderabad
- W RTC, Cross Road, Hyderabad
- SW Mangalagiri, Vijayawada

### BMW KUN Exclusive

- SW Meenambakkam, Chennai
- S EA Mall, Chennai
- S Ambattur, Chennai
- W Ambattur, Chennai
- SW Avinashi Road, Coimbatore
- SW Virudhunagar, Madurai

### BMW Navnit Motors

- S Lavelle Road, Bengaluru
- W Bethahalasoor Post, Bengaluru
- SW Hosur Road, Bengaluru
- SW Kodikal, Mangaluru

SW Showroom and Workshop S Showroom W Workshop

SEARCH



Scan to visit the BMW Online Shop